

USER MANUAL

Si-CPE320

MULTIFUNCTION PANEL TRANSMITTER

Table of contents

1. Safety instructions	5
1.1 Warnings.....	5
1.2 Environment protection	5
1.3 Symbols used	5
2. Conformity and standard	6
2.1 FCC rules	6
2.2 Canadian standard	6
3. Introduction	7
3.1 Description of the transmitter	7
3.1.1 Overall description.....	7
3.1.2 Screen description	7
3.2 Connections.....	8
4. Mounting	9
5. Electrical connections	10
6. First Start-up	11
6.1 Set the transmitter	11
6.2 Connect a probe.....	11
6.3 Set a channel	12
6.4 Set an output	13
6.5 Disconnect a probe.....	13
7. Transmitter features	14
7.1 General features.....	14
7.2 Features of the housing	14
7.3 Dimensions	15
7.4 Possible optional measurements	15
8. Set the transmitter	16
8.1 Set the language	16
8.2 Set the country.....	16
8.3 Set the date, time zone and time	16
8.4 Set the brightness	16
9. Set inputs and outputs	17
9.1 Set the measurement channels	17
9.2 Set the outputs.....	17
9.2.1 Set the analog outputs	17
9.2.2 Perform an output diagnostic.....	18
9.2.3 Set the digital output (Modbus RTU)	19
9.3 Set the probes and the pressure module	19
9.3.1 Normative values.....	19
9.3.2 Configure the compensation of a CO ₂ or hygrometry probe	19
9.3.3 Configure the differential pressure module.....	20
9.4 Set the alarms	22
9.4.1 Set the alarm thresholds	22
9.4.2 Set the alarms parameters	22
9.5 Set the autozero.....	23
10. Security and connectivity	24
10.1 Wireless communication	24
10.2 Define the security code	24
10.3 Define the Touch Lock functionality.....	24
10.4 Reset instrument from factory.....	24
11. Information about transmitter, probes and module	26
11.1 Instrument, probes and module information.....	26

11.2 Adjustment and calibration information	26
11.3 Probe update	26
12. Modbus	27
12.1 Configuration of parameters	27
12.2 Functions	27
12.3 Data format	27
12.4 Description of function and Modbus connections	27
12.4.1 Device	27
12.4.2 Channels	28
12.4.3 Outputs	28
12.4.4 Alarms	29
12.4.5 Probes and module parameters	29
12.4.6 Normative values	30
12.4.7 Alarms	30
13. Maintenance and precautions for use	32
13.1 Maintenance	32
13.2 Precautions for use	32

1. Safety instructions

Before using the device, please read carefully this user manual. It delivers important information about the device operations, maintenance and storage.

1.1 Warnings

- Interior use.
- Respect the measuring ranges of the probes and modules connected to the transmitter.
- This device has been developed to measure simultaneous parameters including differential pressure, temperature (Pt100 and thermocouple), hygrometry, air quality (CO/CO₂/VOC), air velocity, airflow, air change rate. It must not be used in any other purpose.
- This device has been developed and produced to be sold exclusively to trained and qualified HVACR technicians and engineers. Appropriate training might be necessary in order to ensure safe use of this instrument. Sauermann is not responsible for any possible accident during its use.
- Please always use the device in accordance with its intended use and within parameters described in the technical features in order not to compromise the protection ensured by the device.
- When using the device, the safety of the system integrating the device is the responsibility of the system assembler.
- This device can pose a risk for pacemaker wearers. Respect a distance of at least 10 cm (4") between the device and the wearer.
- Respect a safety distance with other electronic devices like computers, credit cards, computer or TV screens which could be damaged by the magnetic field of the apparel.
- Only the accessories provided with the device or available as an option must be used.
- Do not use the device if it is damaged or if it operates abnormally. Inspect the device before every use. In case of doubt, please contact Sauermann's After-sales service.
- Do not authorize pressures beyond the device limits. Please refer to the technical features described in this user manual.
- The device must not be exposed to rain or any other humid environments (> 85 %RH) without using a proper protection.
- Do not use the device next to explosive and corrosives gases, vapours or dust.
- Do not place your fingers in movable zones of the device (articulations).
- The device must not be used in ATEX zones according to applicable standards.
- Do not store the device with solvents. Do not use desiccants. Do not use isopropanol.
- During use, keep inspecting the device and accessories for effective operation and your own safety.
- Do not give this product to a child.
- If the device falls or in case of similar inconveniences, or if an irregular malfunction appears, please send back the device to Sauermann's After-sales service for a technical check and to ensure your own safety.

1.2 Environment protection

Send back the device at its end of working life for waste collection center of electrical and electronic components (according to local regulations), or send it back to Sauermann to ensure a required waste collection in the respect of the environment.

1.3 Symbols used

For your safety and in order to avoid any damage of the device, please follow the procedure described in this user manual and read carefully the notes preceded by the following symbol:



The following symbol will also be used in this user manual:

Please read carefully the information notes indicated after this symbol.

© 2023 SAUERMANN. All rights reserved. Sauermann and Sauermann Control App are the exclusive property of Sauermann. Non contractual document. The products functionalities and visual appearances can be modified without prior notice. Smartphone or tablet are not supplied with Sauermann products.

2. Conformity and standard

The transmitter complies with 2015/863 EU (RoHS 3). Document available on request.

Hereby, Sauermann Industrie SAS declares that the radio equipment type Si-CPE320 is in compliance with Directive 2014/53/EU. The full text of the EU declaration of conformity is available at the following internet address: sauermanngroup.com.

2.1 FCC rules

This equipment has been tested and found to comply with the limits for a Class B digital device, pursuant to part 15 of the FCC Rules. These limits are designed to provide reasonable protection against harmful interference in a residential installation. This equipment generates, uses and can radiate radio frequency energy and, if not installed and used in accordance with the instructions, may cause harmful interference to radio communications. However, there is no guarantee that interference will not occur in a particular installation. If this equipment does cause harmful interference to radio or television reception, which can be determined by turning the equipment off and on, the user is encouraged to try to correct the interference's by one or more of the following measures:

- Reorient or relocate the receiving antenna.
- Increase the separation between the equipment and receiver.
- Connect the equipment into an outlet on a circuit different from that to which the receiver is connected
- Consult the dealer or an experienced radio/TV technician for help.

Changes or modifications not expressly approved by Sauermann could voice the user's authority to operate the equipment.

This device complies with part 15 of the FCC Rules.

Operation is subject to the following two conditions:

1. This device may not cause interference, and
2. This device must accept any interference received, including interference that may cause undesired operation.

2.2 Canadian standard

This device contains licence-exempt transmitter(s)/receiver(s) that comply with innovation, Science and Economic Development Canada's licence-exempt RSS(s). Operation is subject to the following two conditions:

1. This device may not cause interference
2. This device must accept any interference, including interference that may cause undesired operation of the device.

3.1 Description of the transmitter

3.1.1 Overall description

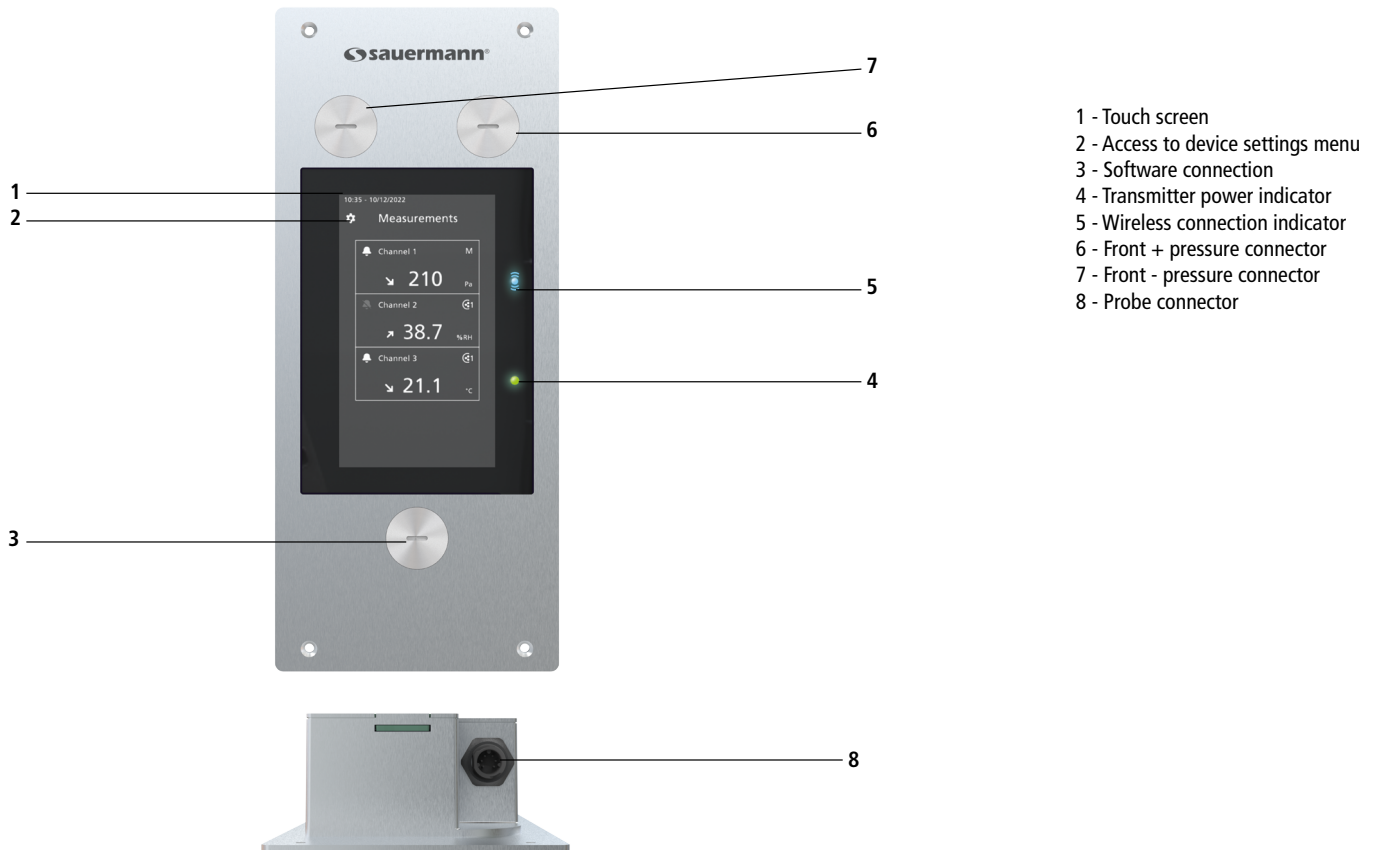

3.1.2 Screen description

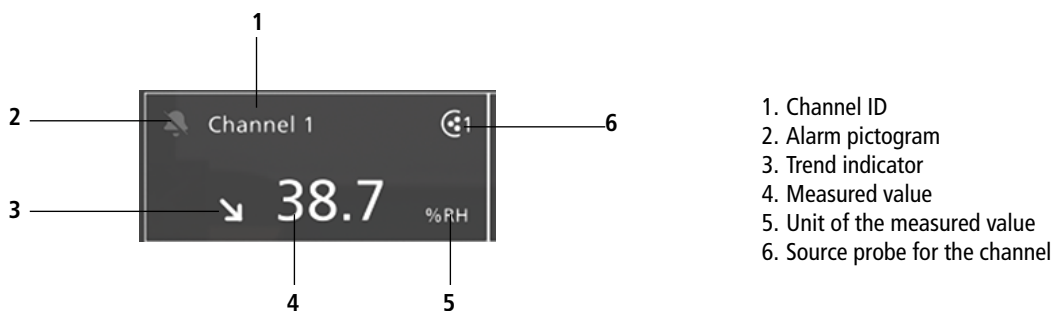

Trend indicator: on the screen, a trend indicator represented by a rising arrow, a going down arrow or a stable arrow is displayed on the left of the measurement unit. It means the calculation of a moving average on the last hour (M1) to compare with a moving average on the last 5 minutes (M2):

- If $M1 = M2$, the trend is stable.
- If $M1 < M2$, the trend is upwards.
- If $M1 > M2$, the trend is downward.

This trend indicator is displayed after 5 minutes.

Alarm pictogram: on the screen, an alarm pictogram is displayed for each channel. Two different pictograms can be displayed:



There is no alarm configured and activated for the channel



An alarm is configured and activated for the channel

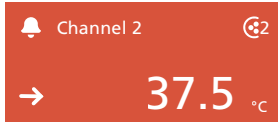

In case of alarm, the background of the channel concerned by the alarm turns red on the screen.

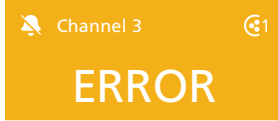

In case of error, the concerned channel's background will change to orange. By tapping on the screen a message with additional information about the problem is displayed.

3.2 Connections

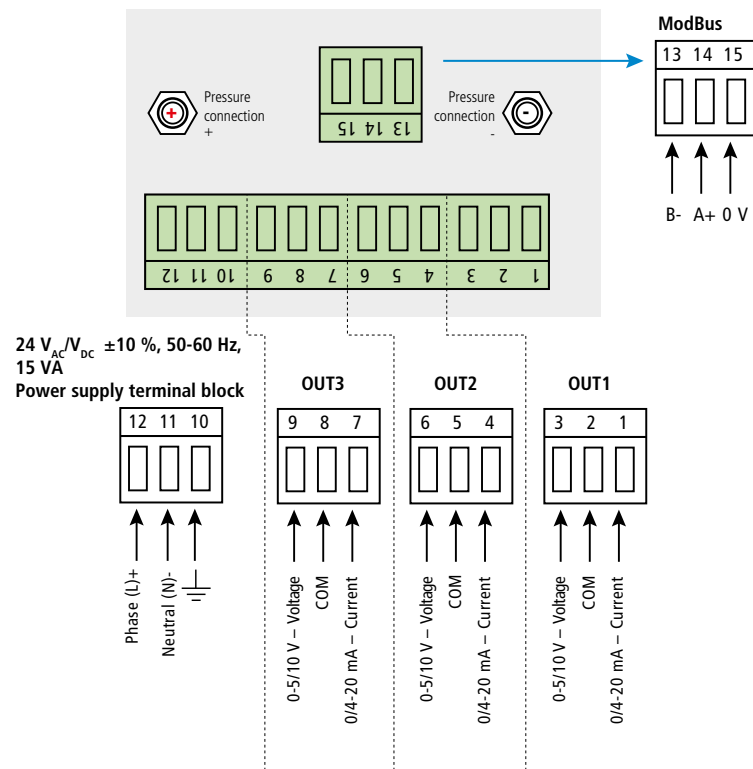

4. Mounting



The transmitter must be mounted before any wire connections.
The transmitter must not be powered before mounting it.

To install the transmitter on a wall:

- Make a cutting of 200 x 82 mm in the wall.
- Drill 4 holes around the cutting as shown below.
- Insert the transmitter into the wall.
- Fix it with the 4 screws (supplied with the transmitter).



The fixing screw is in a plastic bag into the box of the Si-CPE320. Type of screw: Cruciform screw
Ø 3.5 x 12 mm

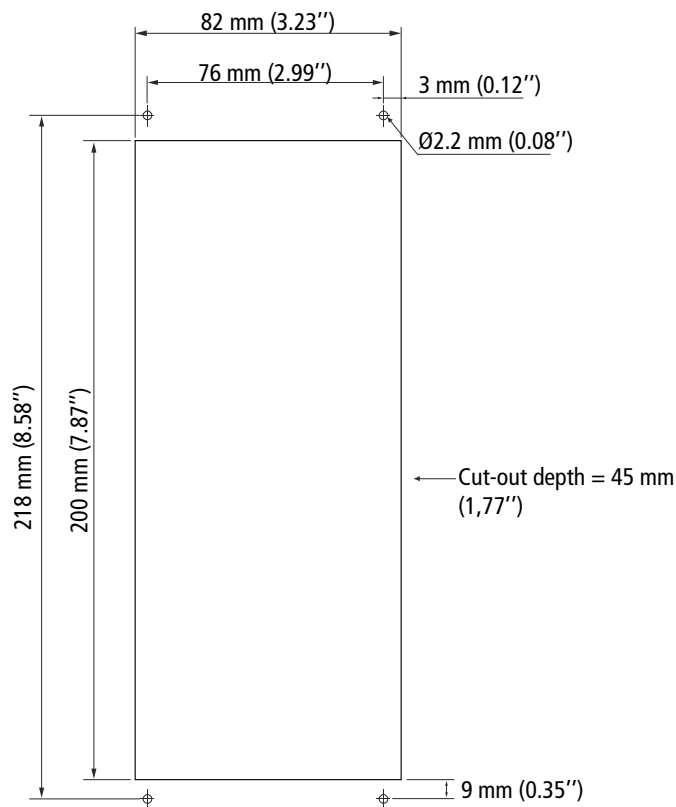

To ensure a proper isolation of the rear side of the instrument,, use sealant of silicone type between the wall and the transmitter. If VHP (Vaporized hydrogen peroxide) is used, check that the seal is VHP resistant.

5. Electrical connections



Electrical connections are as per NF C 15-100 standard.



This connection must be made by a formed and qualified technician. Whilst making the connection, the transmitter must not be energized. The presence of a switch or a circuit breaker upstream the device is compulsory.

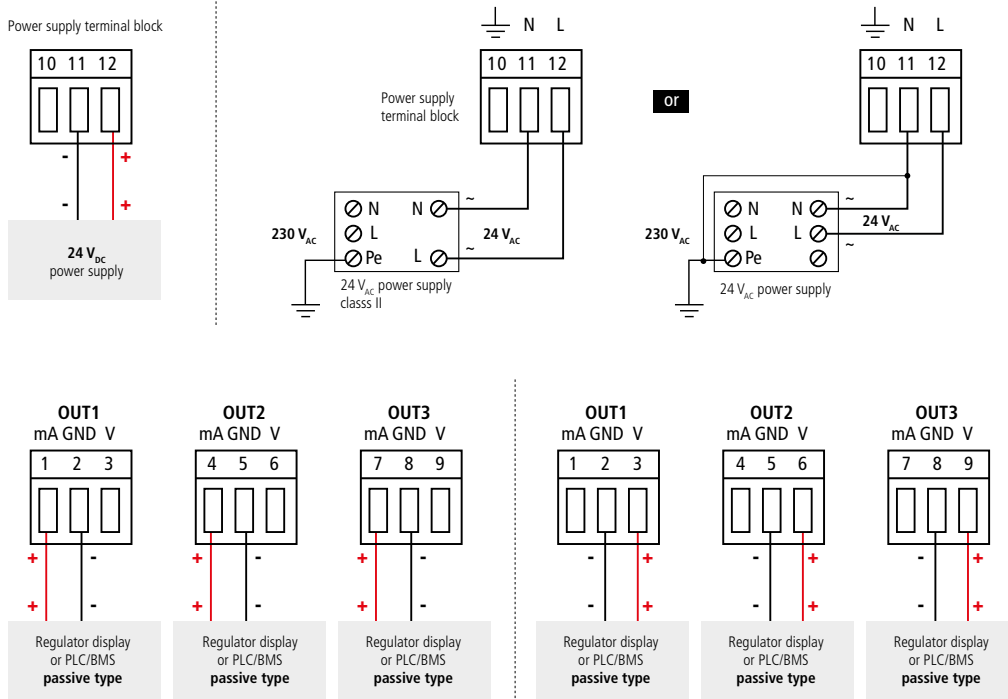

6. First Start-up

When the transmitter is first started up, parameters of the transmitter must be set.

6.1 Set the transmitter

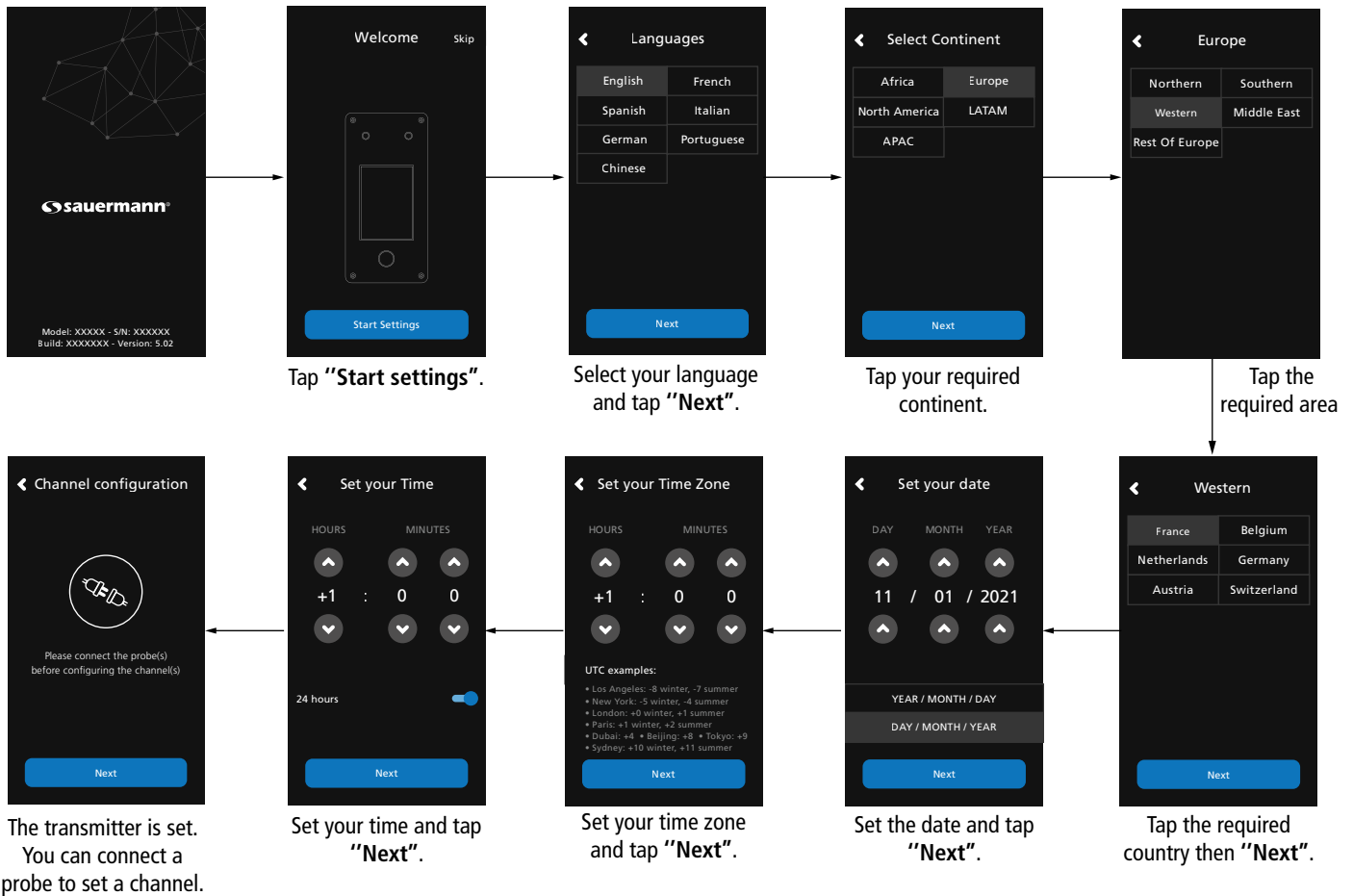

Download Sauermann Control App

6.2 Connect a probe

- After removing the protection cap on the transmitter connector, present the probe connector (a) with its arrow and padlock face to the transmitter connector (b).
- Push in the probe connector (a) into the transmitter connector (b) until you hear a click. The probe is correctly connected.

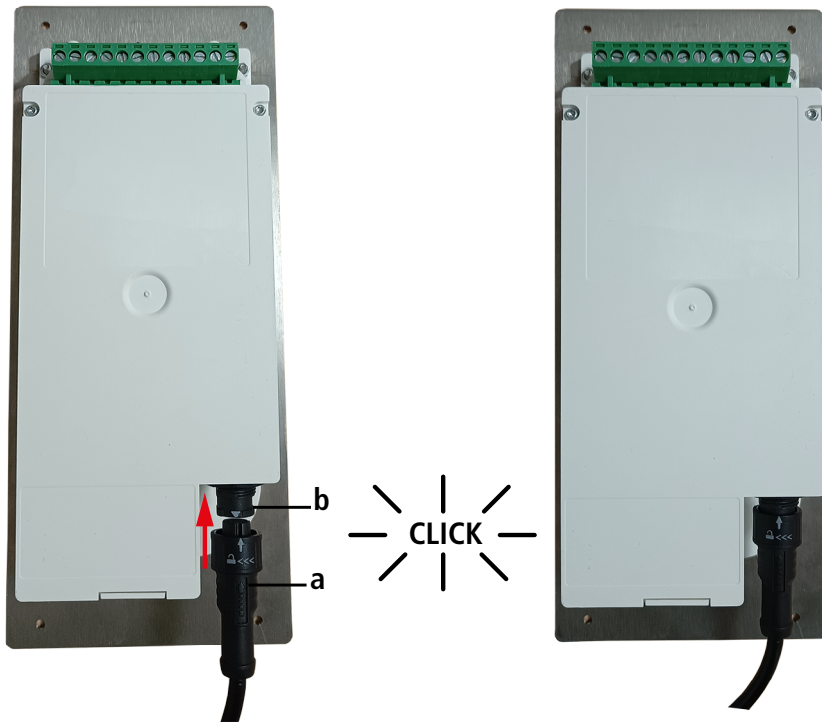

6.3 Set a channel

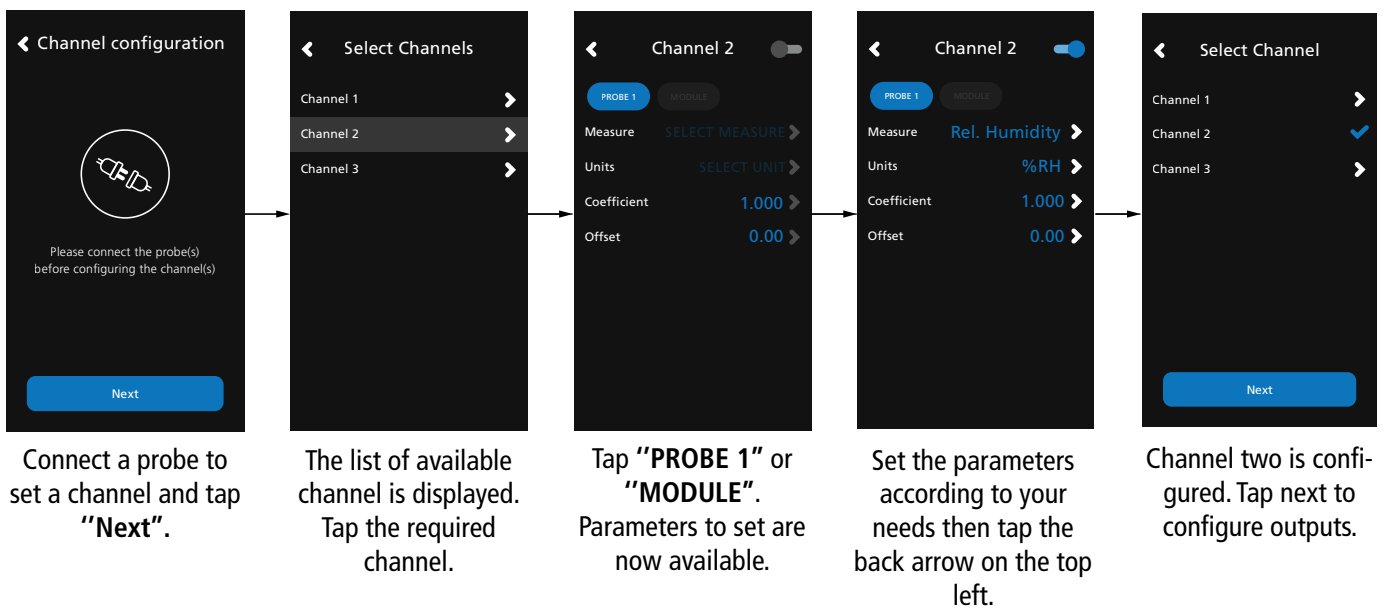

Download Sauer mann Control App

6.4 Set an output

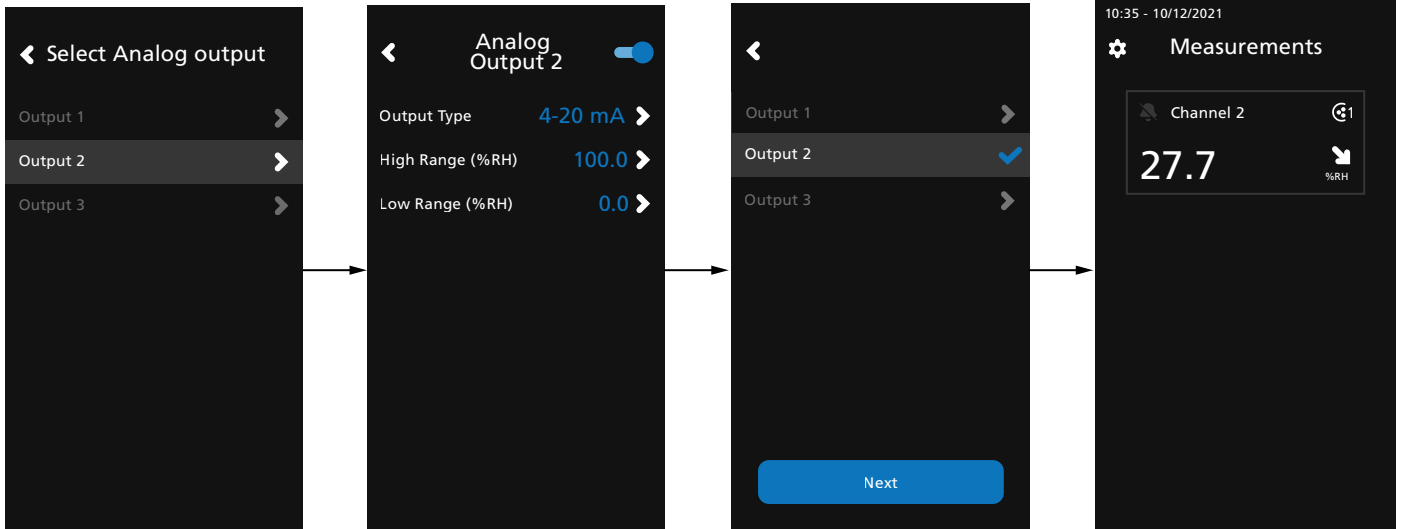

Tap the output to set corresponding to the previously configured channel.

Activate the output tapping  .
Set the output type and high and low range values then tap the back arrow on the top left.

Tap "Next" to display measures.



Download Sauer mann Control App

6.5 Disconnect a probe

- Turn the ring (c) of the probe connector to the left.
- Pull the probe connector (a) away from the transmitter connector (b).



7. Transmitter features

7.1 General features

Power supply	24 V _{AC} / V _{DC} ±10% Warning: risk of electric shock 
Outputs	3 x 0/4-20 mA or 3 x 0-5/10 V (4 wires) Common mode voltage Maximum load: 500 Ω (0/4-20 mA) Minimum load: 1 KΩ (0-5/10 V)
Galvanic isolation	On the output
Consumption with probe and without option	15 VA
Electrical connections	Screw terminal block for cables from 0.05 to 1.5 mm ² or from 30 to 16 AWG Carried out according to the code of good practices
Communication RS485	Modbus RTU protocol, configurable communication speed from 2400 to 115,200 Bauds
Wireless communication (option)	Range frequency from 2402 MHz to 2480 MHz with a transmission power of 0 dBm. Range up to 15 m (50 ft), depending on smartphone radio strength. Minimum required versions: Android 5.0, iOS 12.4, BLE 4.0
Audible alarm	Buzzer (60 dB at 10 cm)
Environment and type of fluid	Air and neutral gases
Conditions of use (°C/%RH/m)	From -10 to 50 °C (14 to 122 °F) In non-condensing condition From 0 to 2000 m (0 to 6561')
Storage temperature	From -10 to 70 °C (14 to 158 °F)
Security	Protection class 2 - Pollution degree 2 - Overvoltage category 2
European directives	2014/30/EU EMC - 2014/35/EU Low Voltage - 2014/53/EU (RED) - 2015/863 EU (RoHS 3) - 2012/19/EU WEEE

7.2 Features of the housing





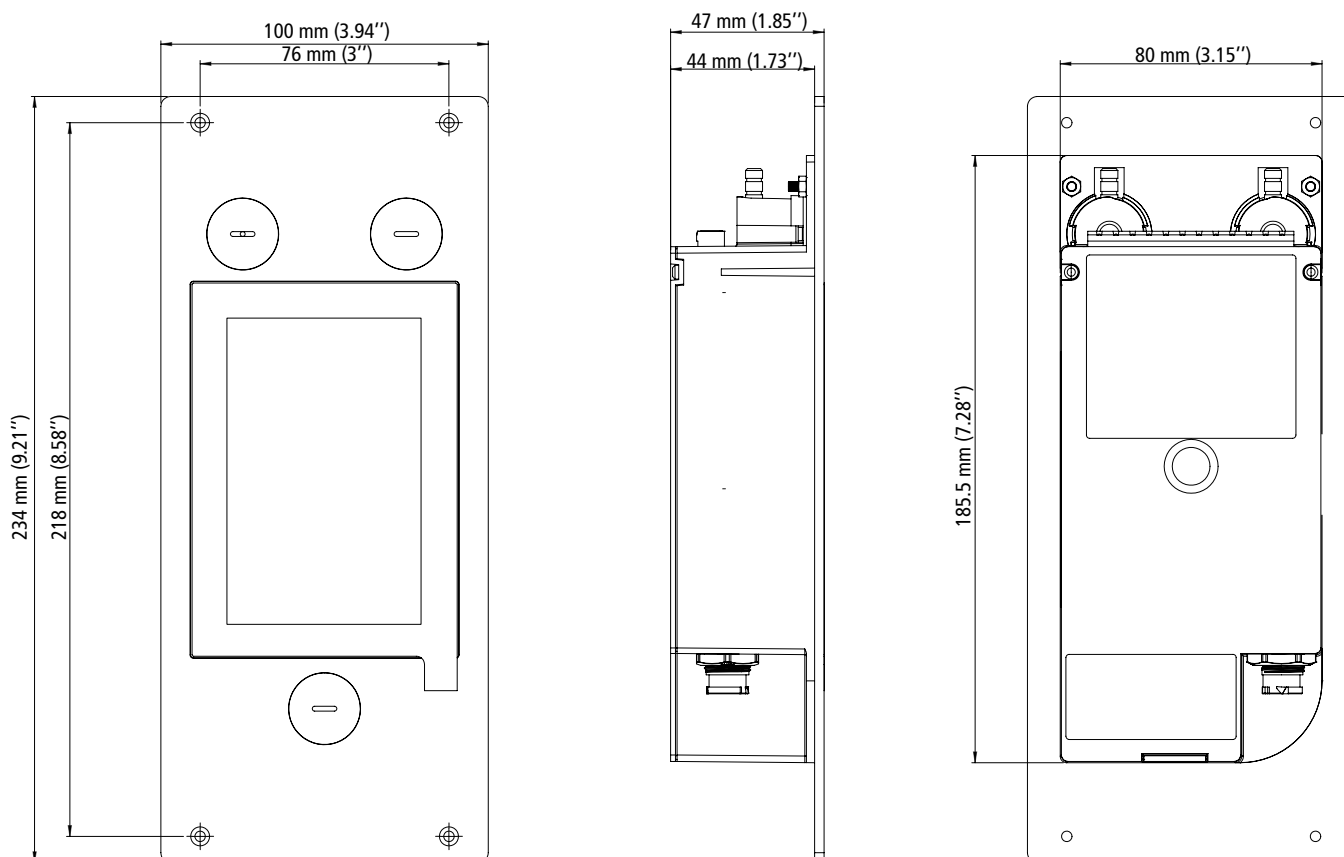

Front face	Brushed stainless steel 316 L
Back housing	ABS V0
Protection	IP66 in front face, resistant against VHP
Display	Graphic touchscreen Size: 480 x 272 pixels
Height of the digits	14 mm (0.56")
Back fittings	Barbed fitting Ø 5.2 mm (Ø 0.2")
Weight	684.4 g (1.5 lb)

7.3 Dimensions



7.4 Possible optional measurements

The following probes and modules are available as an option for Si-CPE320 transmitters. For further details please see the probes technical data sheet for class 320 transmitters.

Probes / modules	Measuring ranges	Calculated parameters
 Relative humidity / temperature probe	0 to 100 %RH and -40 to 150 °C (-40 to 302 °F) (according to the probe)	Dew point: -50 to 100 °C _{td} (-58 to 212 °F _{td}) Wet-bulb temperature: -50 to 100 °C _{tw} (-58 to 212 °F _{tw}) Frost point: -50 to 100 °C _{tf} (-58 to 212 °F _{tf}) Enthalpy: 0 to 15,000 kJ/kg Absolute humidity: 0 to 1000 g/m ³ Mixing Ratio: 0 to 1000 g/kg
 Temperature probe	-80 to 150 °C (-112 to 302 °F)	N/A
 Air velocity / temperature probe	0 to 30 m/s (0 to 98.4 fps) and 0 to 50 °C (32 to 122 °F)	Air flow: 0 to 999,999 m ³ /h (0 to 588,577 cfm) Air change rate: 0 to 1000 ACH
 CO probe	0 to 500 ppm	N/A
 CO ₂ probe	0 to 10,000 ppm	N/A
 VOC probe	TVOC: 0 to 1000 ppb CO ₂ eq: 400 to 2000 ppm	N/A

8. Set the transmitter

"Device Settings" menu allows to set the following items for the transmitter:

- Language
- Country
- Date, time and time zone
- Brightness

To access this menu:

- Tap  on the measurement screen.
- Enter the security code.

 Default security code is **0101**. This code can be modified in "**Security/Connectivity**" menu. See chapter 9.2 on page 24.

- Tap "**Device Settings**".

8.1 Set the language

"Device settings" menu is displayed.

- Tap "**Languages**".
- Tap the requested language.

 Available languages: English, French, Spanish, Italian, German, Portuguese and Chinese.

8.2 Set the country

"Device settings" menu is displayed.

- Tap "**Country**".
- Select the continent.
- Select the country.

8.3 Set the date, time zone and time

"Device settings" menu is displayed.

- Tap "**Date, Time Zone, ...**".
- Tap "**Date**", "**Time**" or "**Time zone**" depending on the settings to be made.
- Perform the settings.

8.4 Set the brightness

"Device settings" menu is displayed.

- Tap "**Brightness**".
- Adjust the brightness of the screen from 1 to 5.
- Tap the back arrow on the top left of the screen to back to "**Device Settings**" menu.

9. Set inputs and outputs

"I/O Configurations" menu allows to set the following items:

- **Channels:** activate and set the probes and modules connected to the transmitter
- **Outputs:** activate and set outputs corresponding to the channels
- **Probes and Modules:** define normative values according to probes and modules connected to the transmitter and define some parameters linked to probes and modules
- **Alarms:** activate and set alarm features
- **Autozero:** activate and set the pressure autozero interval

To access this menu:

- Tap  on the measurement screen.
- Tap the security code.

 Default security code is **0101**. This code can be modified in "Security/Connectivity" menu. See chapter 9.2 on page 24.

- Tap "I/O Configurations".

9.1 Set the measurement channels

"I/O Configurations" menu is displayed.

- Tap "Channels".
- Tap the desired channel number (Channel 1, 2 or 3).
Features of the channel are displayed.
- Tap "PROBE 1" or "MODULE" according to the required attribution for the channel.
"Measures" becomes available.
- Tap "Measures".
- Select the required parameter then tap the back arrow on the top left of the screen.
- Tap "Units".
- Select the required measurement unit then tap the back arrow on the top left of the screen.
The channel is automatically activated (toggle switch is on).
- If required, enter a coefficient and an offset to the channel.
- Tap the back arrow on the top left of the screen until measurement screen is displayed.
Values measured by the probe or the module are displayed.



Special case: two units are available for the VOC probe: ppb and ppm CO₂ equivalent. If ppm is selected, the transmitter will take 15 minutes to display the first measurements (pre-heating phase).



The channel name can be changed:

- Tap  next to the channel name to edit it.
- Enter a name. Maximum characters: 13.
- Tap OK to validate.

9.2 Set the outputs

Two types of outputs are available: analog outputs and digital outputs

9.2.1 Set the analog outputs



At least one measurement channel must be configured. If no channel has been configured, no analog output will be delivered.

"I/O Configurations" menu is displayed.

- Tap "Outputs".
- Tap "Analog Outputs".
- Tap the desired output (Output 1, 2 or 3 depending on the number of the previously configured channel).
Features of the output are displayed.
- Tap  on the top right of the screen to activate the output
- Tap "Output type".
- Select the output type: 0-5 V, 0-10 V, 0-20 mA or 4-20 mA then tap the back arrow on the top left of the screen.
- Tap "High range".
- Define the high range value for the output then tap the back arrow on the top left of the screen.
- Tap "Low range".
- Define the low range value for the output then tap the back arrow on the top left of the screen.

9.2.2 Perform an output diagnostic

This function allows to check on a measurement device (multimeter, regulator or automate) the proper functioning of the outputs. The transmitter will generate a voltage (between 0 and 10 V) or a current (between 0 and 20 mA) according to the setting of the type of output.

- For a 0-10 V output signal, the transmitter will generate 0 – 5 or 10 V.
- For a 0-5 V output signal, the transmitter will generate 0 – 2.5 or 5 V.
- For a 4-20 mA output signal, the transmitter will generate 4 – 12 or 20 mA.
- For a 0-20 mA output signal, the transmitter will generate 0 – 10 or 20 mA.



Before carrying out the output diagnostics, all connections and configurations of the transmitter must be enabled, to avoid any damage on the transmitter and the measurement device.

- Select an output for the output diagnostic.
- OUT1, OUT2 or OUT3 indicated on the connection label.
- Connect a measurement device on the channel 1, 2 or 3.

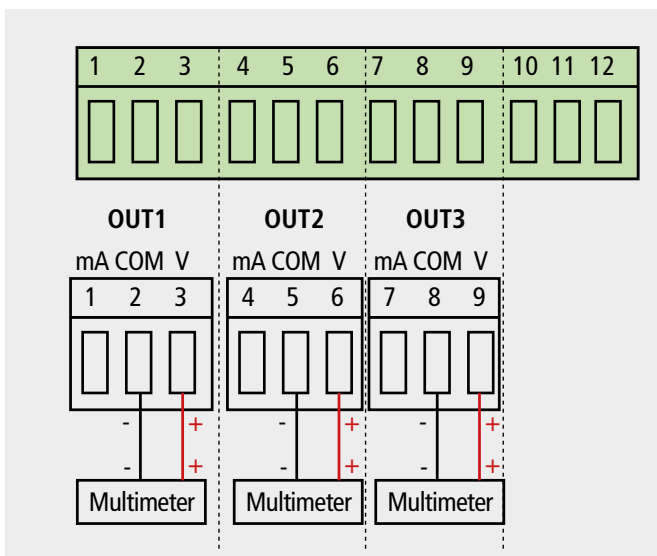

Connection of the 0/10 V voltage output

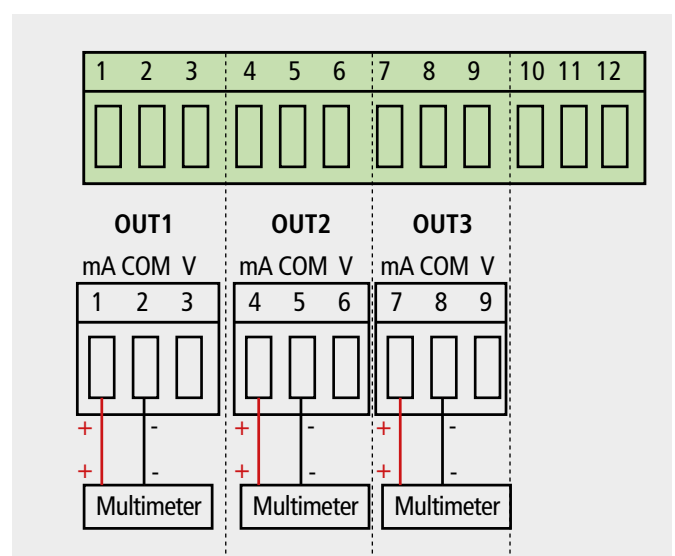

Connection of the 0/4-20 mA current output

Once the connection to the measurement device is complete, the output diagnostic on several check points can be performed:

"I/O Configurations" menu is displayed.

- Tap "Outputs".
- Tap "Analog Outputs".
- Tap "Diagnostic" line.

- Tap the required value.



The values proposed will depend on the type of output previously selected. For example, if the output type is 4-20 mA, proposed values will be 4 mA, 12 mA and 20 mA.



If the deviations are too large (> 0.05 V or > 0.05 mA) between the signal issued and the value displayed on the multimeter, we recommend that you return the transmitter to our factory.

9.2.3 Set the digital output (Modbus RTU)

"I/O Configurations" menu is displayed.

- Tap "Outputs".
- Tap "Digital Outputs".
Features of Modbus are displayed.
- Tap "Slave address".
- Define the slave address number between 1 and 255 then tap the back arrow on the top left of the screen.
- Tap "Baud rate".
- Select the baud rate between 2400, 4800, 9600, 19,200, 38,400, 57,600, 76,800 and 115,200 then tap the back arrow on the top left of the screen.



Default baud rate: 9600

9.3 Set the probes and the pressure module

This menu allows to define relevant values related to the probes and the pressure module connected to the transmitter and define some parameters linked to them:

- **For an air velocity probe (hotwire probe):** duct dimensions and type of section, the correction factor, the integration in air velocity and the compensation in atmospheric pressure for airflow calculation.
- **For the pressure module:** for air velocity and airflow calculation the duct dimensions and type of section, the airflow coefficient, the pressure probe coefficient, the integration in pressure and autozero duration.
- **For a CO₂ probe:** the compensation in atmospheric pressure
- **For an hygrometry probe:** the compensation in atmospheric pressure for the psychrometry calculations

9.3.1 Normative values

For the airflow calculations, it is possible to convert the value into normative values (ex: Nm³/h).

The conversion can be done according to two standards:

- DIN 1343: 1013.325 hPa, 273,15 K (0°C)
- ISO 2533: 1013.325 hPa, 288,15 K (15°C)

"I/O Configurations" menu is displayed.

- Tap "Probes & Modules".
The screen displays the connected probes and modules.
- Tap "Normative values".
- Select the normative value according to your needs: DIN 1343 or ISO 2533 then tap the back arrow on the top left of the screen.

9.3.2 Configure the compensation of a CO₂ or hygrometry probe



A CO₂ or hygrometry probe must be connected to the transmitter.

Set the compensation in atmospheric pressure:

"I/O Configurations" menu is displayed.

- Tap "Probes & Modules".
The screen displays the connected probes and modules.
- Tap the line corresponding to the temperature/hygrometry probe or to the CO₂ probe.
- Tap "Atmo pressure".

- Tap **"Unit"** to select the atmospheric pressure unit.
- Tap **"Atmo pressure"** to enter a value. This value must be between:
 - 0 and 4000 hPa
 - 0 and 4000 mbar
 - 0 and 3000.24 mmHg
 - 0 and 10 000 m (altitude)

9.3.3 Configure the differential pressure module

Select the measuring device:

"I/O Configurations" menu is displayed.

- Tap **"Probes & Modules"**.
The screen displays the connected probes and modules.
- Tap the line corresponding to the pressure module.
- Tap **"Device"**.
- Tap **"Type"**.
- Tap the desired measurement mean between:
 - Pitot tube L (coefficient: 1.0015)
 - Pitot tube S (coefficient: 0.84)
 - Debimo blades (coefficient: 0.8165)
 - Other (free coefficient)

 If **"Other"** is selected, the coefficient of the other measurement mean should be entered. This coefficient must be between 0.0001 and 9.9999.

- Tap the back arrow on the left of the screen to back to configuration menu.

Select the type of duct section:

"I/O Configurations" menu is displayed.

- Tap **"Probes & Modules"**.
The screen displays the connected probes and modules.
- Tap the line corresponding to the pressure module.
- Tap **"Section"**.
- Tap **"Shape"**.
- Tap the requested section:
 - Rectangular
 - Circular
 - Custom coefficient

For a rectangular section:

- Tap **"Unit"** to select the unit: mm or in, then tap the back arrow on the top left of the screen.
- Enter the length and width of the section.

 Length and width of the section must be between 1 and 3000 mm (0.039 to 118.11 in).

For a circular section:

- Tap **"Unit"** to select the unit: mm or in, then tap the back arrow on the top left of the screen.
- Enter the diameter.

 Diameter of the section must be between 1 and 3000 mm (0.039 to 118.11 in).

For a custom coefficient (airflow coefficient):

- Tap "**Coefficient**" to enter an airflow coefficient, then tap the back arrow on the left of the screen.

This airflow coefficient allows to calculate an airflow from the pressure. It is indicated by the manufacturer of the devices supplied with pressure connections (+ and -). From the square root of the measured pressure (Delta P) and from this coefficient, you get the airflow. $Airflow = C_d \times \sqrt{\Delta P}$



The coefficient must be between 0.1 and 9999.9.

Set the compensation in temperature:

It is possible to modify the compensation temperature value. Indeed, the measured value of air velocity and airflow with a Pitot tube or Debimo blades (or other differential pressure element) depends on the operating temperature. It is required to enter the operating temperature in order to get more accurate results. It is possible to enter the value manually, to use the temperature value from a connected temperature probe to the transmitter or to use the temperature measured by an internal sensor for an automatic temperature compensation.

"I/O Configurations" menu is displayed.

- Tap "**Probes & Modules**".
The screen displays the connected probes and modules.
- Tap the line corresponding to the pressure module.
- Tap "**Temperature**".
- Tap "**Source**" to select the temperature source between:
 - Internal sensor
 - Manual: enter manually a temperature: press "**Manual**" then select the unit (°C or °F) then tap "**Temperature**" to enter a value between -50 and 50 °C.
 - Probe 1: the transmitter will take into account the measured temperature by a temperature probe connected to the transmitter at the "Probe 1" location.

Set the compensation in atmospheric pressure:

"I/O Configurations" menu is displayed.

- Tap "**Probes & Modules**".
The screen displays the connected probes and modules.
- Tap the line corresponding to the pressure module.
- Tap "**Atmo pressure**".
- Tap "**Unit**" to select the atmospheric pressure unit.
- Tap "**Atmo pressure**" to enter a value. This value must be between:
 - 0 and 4000 hPa
 - 0 and 4000 mbar
 - 0 and 3000.24 mmHg
 - 0 and 10 000 m (altitude)

Enter an integration in pressure:

"I/O Configurations" menu is displayed.

- Tap "**Probes & Modules**".
The screen displays the connected probes and modules.
- Tap the line corresponding to the pressure module.
- Tap "**Integr. & Correction**".
- Tap "**Integration**".
- Enter the integration then tap the back arrow on the top left of the screen.



The pressure integration must be between 0 and 9.

Enter a correction factor:

The correction factor allows to adjust the transmitter according to data in air velocity of the installation.

How to calculate it? For example, the air velocity in your section is 17 m/s and the transmitter displays 16.6 m/s.

The coefficient to apply is 17 / 16,6, it means 1.024.

"I/O Configurations" menu is displayed.

- Tap "Probes & Modules".
The screen displays the connected probes and modules.
- Tap the line corresponding to the pressure module.
- Tap "Integr. & Correction".
- Tap "Correction factor".
- Enter the correction factor then tap the back arrow on the top left of the screen.



The correction factor must be between 0 and 9.

9.4 Set the alarms

This part allows to activate and define the alarms conditions on one or several channels.



One channel must be configured at least (see chapter 8.1 on page 17)

If no channel has been configured, the alarm corresponding to the channel will be not available.

9.4.1 Set the alarm thresholds

"I/O Configurations" menu is displayed.

- Tap "Alarms".
The screen displays the alarm available.
- Tap the line of the alarm to configure.
- Tap "Threshold up" to enter and validate the high threshold then tap the back arrow on the top left of the screen.
- Tap "Threshold down" to enter and validate the low threshold then tap the back arrow on the top left of the screen.
- Tap  on the top right of the screen to activate the alarm.

9.4.2 Set the alarms parameters

It's then possible to set the parameters of the alarm: Time delay, Hysteresis, Acoustic alarm and Acknowledgement.

"I/O Configurations" > "Alarm" menu is displayed.

Set the time delay:

Time Delay: this is the time in seconds before the alarm is triggered when the measurement exceeds the threshold or is below the threshold.

Example: time delay set to 5 s. The alarm will be triggered when the threshold is exceeded for 5 s or more or when the measurement is below the threshold for 5 s or more.

- Tap "Alarm parameters".
- Tap "Time delay".
- Enter the time delay in second.



The time delay must be between 0 and 600 s.

Set the hysteresis:

Hysteresis: hysteresis value impacts the return to normal state. Example for an alarm with a high threshold at 80 Pa, a low threshold at 20 Pa and a hysteresis at 5 Pa: the alarm stay triggered until the value goes below 75 (or up to 25).

- Tap "Alarm parameters".
- Tap "Hysteresis".
- Enter the hysteresis.



The hysteresis must be between the low threshold and the high threshold (only if two thresholds are configured).

Set the alarm acknowledgement

Alarm acknowledgement: when an alarm goes off, it is possible to acknowledge it by pressing the value in alarm on the screen: the audible alarm, if activated, turns off and the displayed value remains in red during the acknowledgement duration. At the end of the acknowledgement duration, if the transmitter is still in alarm state, the audible alarm is reactivated.

- Tap "**Alarm parameters**".
- Tap "**Acknowledge**".
- Enter the alarm acknowledgement in minute.



The acknowledgement duration must be between 0 and 60 min.

9.5 Set the autozero

Enter the interval between two autozeros: thanks to the temperature compensation of the gain (from 0 to 50°C / 14 à 122 °F) and to the autozero system, Class 320 transmitters guarantee an excellent long-term stability, along with a great measurement accuracy.

Autozero principle: the microprocessor drives a solenoid valve that compensates for any long-term drift of the sensitive element.

Compensation is made by regular automatic adjustment of the zero. True differential pressure measurement is then made regardless of the environmental conditions of the transmitter.

"**I/O Configurations**" menu is displayed.

- Tap "**Autozero**".
- Tap "**Autozero interval**".
- Enter the autozero interval in minute.



The autozero interval must be between 10 and 60 min.

The autozero is managed by a solenoid valve. The behaviour of this solenoid valve is linked to the ambient temperature. An automatic monitoring of the internal temperature of the device ensures the correct operation of the solenoid valve.

When starting the device or when the solenoid valve is activated for the first time, the solenoid valve is automatically triggered for 30 seconds (160 seconds if the internal temperature of the device is lower than 0 °C/32 °F) if the internal temperature of the device is higher than 0 °C/32 °F.

During the first 20 minutes, the solenoid valve is automatically triggered to perform an autozero every 3 minutes. Between 20 minutes and 60 minutes, the solenoid valve is automatically triggered to perform an autozero every 10 minutes.

After the first hour of operation, the device will perform an autozero according to the user's configuration.

If the internal temperature of the device falls below 1 °C/34 °F, the solenoid valve is automatically activated every 30 minutes. The autozero is not taken into account during this operation.

10. Security and connectivity

This part allows to manage the wireless communication, to define the security code and the touch lock functionality.

To access this menu:

- Tap  on the measurement screen.
- Tap the security code.



Default security code is **0101**. This code can be modified in "**Security/Connectivity**" menu. See chapter 9.2 on page 24.

10.1 Wireless communication

It's possible to activate and deactivate the wireless communication. The wireless communication must be activated to use the Sauermann Control app.

"**Security/Connectivity**" menu is displayed.

- Tap  to activate the wireless communication.

or

- Tap  to deactivate the wireless communication.

10.2 Define the security code

To configure the transmitter, and for security purposes, a security code must be entered. The default code is 0101.

This code can be modified:

"**Security/Connectivity**" menu is displayed.

- Tap "**Security code**".
- Tap "**New code**".
- Enter a new code of 4 digits then tap OK.
- Tap "**Confirmation**".
- Confirm the new code then tap OK.
- Tap "**Save code**" button.

10.3 Define the Touch Lock functionality

It's possible to lock the screen of the transmitter after a certain time of non-use. To unlock it, tap the lock icon for 3 seconds.

"**Security/Connectivity**" menu is displayed.

- Tap "**Touch lock**".
- Tap "**Lock delay**".
- Enter the lock delay then tap OK.
- Tap  to activate the touch lock.

10.4 Reset instrument from factory

It's possible to reset the transmitter to factory parameters.

"**Security/Connectivity**" menu is displayed.

- Tap "**Reset Instrument From Factory**".
The transmitter displays a message asking if you are sure to back to factory settings.
- Tap Yes to confirm the reset.

or

- Tap the back arrow on the top left of the screen to cancel.



The transmitter will be reset to original delivery settings. All your configurations will be deleted.
Units and values of measurement settings of the factory setting:

Feature	Default value
Channel N output	Output type 4-20 mA
Channel N range	N/A
Channel N's name	Channel N
Alarms	Off
Display brightness	5
Graph timespan	24 hours
Wireless communication	On
Access code to enter the configuration menu	0101
Modbus output	Off
Modbus address	1
Modbus baud rate	9600 bps
Date and time	Last set value
Device's time zone	Last set value
Correction coefficients	None
ΔP element for Air flow/Air velocity calculation	None
Duct size/conversion factor	None
Autozero of the differential pressure sensor	10 minutes
Pressure integration	0
Air flow/Air velocity standardized value	No
Air flow/Air velocity compensation temperature	Manual, 20 °C
Language	English
Time Zone	UTC+1

11. Information about transmitter, probes and module

"**Information**" menu allows to access to information such as serial numbers, firmware version, date of last adjustment and calibration, date of next service,...

To access this menu:

- Tap  on the measurement screen.
- Tap the security code.

 Default security code is **0101**. This code can be modified in "**Security/Connectivity**" menu. See chapter 9.2 on page 24.

- Tap "**Information**".

11.1 Instrument, probes and module information

"**Information**" menu is displayed.

- Tap "**Instruments and probes**".
- Tap "**Instruments**" or "**Probes/modules**".

The screen displays the following information:

- Model
- S/N (Serial Number)
- Build
- Firmware version

 In case of a trouble with your device and when contacting the after-sale service or the hotline, this information will be useful.

11.2 Adjustment and calibration information

This menu displays information about adjustment and calibration for probes and modules connected to the transmitter.

"**Information**" menu is displayed.

- Tap "**Adjustment & Calibration**".
- Tap the requested probe or module.
- Tap the requested parameter depending on the probe or module previously selected.

The screen displays the following information:

- Last adjustment date
- Last calibration date
- Date of next service

11.3 Probe update

This menu allows to check if a firmware update is available for probes.

"**Information**" menu is displayed.

- Tap "**Probe Update**".

The screen displays the current probe firmware version. If no update is available, the following message is displayed: "Probes are already running the latest firmware."

The screen displays the current probe firmware version. If an update is available, the following message is displayed: "A new probe firmware is available. Installing the new probe firmware will restart the transmitter. Measurements will neither be collected nor available during this process".

- Tap "**Install**".

The transmitter displays the following message: Updating probe X to x.x.xx (firmware version).



Do not disconnect the probe from the transmitter during this step.

Once the installation of the new firmware is finalized, the transmitter restarts and measurements are displayed.

12.1 Configuration of parameters

- Communication speed: between 2400 and 115200 bauds, 9600 bauds by default
- Data bits: 8 bits
- Stop bit: 1 bit
- Parity: None
- Flow control: None
- Transmitter addressing: between 1 and 255 (automatically answers the requests from address 0)
- Data sending: made by words of 2 bytes, in the following order most-significant then least-significant byte

12.2 Functions

- Register function: Function 03
- Register writing: Function 16

12.3 Data format

UNIT8	Byte 1	Byte 0 (lsb)
Value (0x01)	0x00	0x01
Registers	Reg0	
	0x00	0x01

UNIT16	Byte 1	Byte 0 (lsb)
Value (0x0102)	0x01	0x02
Registers	Reg0	
	0x01	0x02

UNIT32	Byte3	Byte2	Byte1	Byte0 (lsb)
Value (0x01020304)	0x01	0x02	0x03	0x04
Registers	Reg0		Reg1	
	0x03	0x04	0x01	0x02

FLOAT32	Byte3	Byte2	Byte1	Byte0 (lsb)
Value (0x01020304)	0x01	0x02	0x03	0x04
Registers	Reg0		Reg1	
	0x03	0x04	0x01	0x02

12.4 Description of function and Modbus connections

12.4.1 Device

Modbus	Register type	Description	Possibilities
1000	STR	Serial number of the transmitter	
1010	STR	Firmware version	
1020	STR	Device identification	
1030	STR	Probe 1 identification	
1060	STR	Probe 1 serial number	
1090	STR	Probe 1 version	
1120	U8	Backlit value	In percent, from 0 to 100.
1150	U8	Graph period	From 0 to 3.
1160	U8	Graph channel	
1200	U8	Language	
1300	U32	Timestamp	

1310	U32	Time offset	
1320	U8	Date format	
1330	U8	Hour format	
1350	BOOLEAN	Sound	
1400	BOOLEAN	Keypad locking	
1410	U16	Safety code	
1500	U8	Modbus slave number	
1510	U32	Modbus speed communication	
1710	BOOLEAN	Activation of the Modbus option	
1900	BOOLEAN	Back to factory configuration	
1910	U8	Delay time (in min) between 2 auto-zeros	From 10 to 60.
1920	BOOLEAN	Instantaneous autozero	

12.4.2 Channels

Modbus	Register type	Description	Possibilities
2000	U8	Unit selection of the channel 1	
2010	U8	Selection of probe or module	
2020	U8	Selected measure	
2030	I8	Measure resolution	Number of digits after comma.
2040	F32	Channel 1 coefficient	
2050	F32	Channel 1 offset	
2100	U8	Unit selection of the channel 2	
2110	U8	Selection of probe or module	
2120	U8	Selected measure	
2130	I8	Measure resolution	Number of digits after comma.
2140	F32	Channel 2 coefficient	
2150	F32	Channel 2 offset	
2200	U8	Unit selection of the channel 3	
2210	U8	Selection of probe or module	
2220	U8	Selected measure	
2230	I8	Measure resolution	Number of digits after comma.
2240	F32	Channel 3 coefficient	
2250	F32	Channel 3 offset	

12.4.3 Outputs

Modbus	Register type	Description	Possibilities
3000	U8	Analog output selection of the channel 1	4-20 mA / 0-20 mA / 0-10 V / 0-5 V
3100	U8	Analog output selection of the channel 2	4-20 mA / 0-20 mA / 0-10 V / 0-5 V
3200	U8	Analog output selection of the channel 3	4-20 mA / 0-20 mA / 0-10 V / 0-5 V
3020	F32	Channel 1 minimum range	
3030	F32	Channel 1 maximum range	
3120	F32	Channel 2 minimum range	
3130	F32	Channel 2 maximum range	
3220	F32	Channel 3 minimum range	
3230	F32	Channel 3 maximum range	

12.4.4 Alarms

Modbus	Register type	Description	Possibilities
Alarm 1			
4000	U8	Alarm mode	0: None, 1: Min, 2: Max, 3: Min/Max
4010	F32	Hysteresis	
4020	F32	Threshold Up	
4030	F32	Threshold Down	
4040	U32	Delay Time	
4050	U32	Delay End	
4060	BOOLEAN	Enabled/Disabled	
4080	BOOLEAN	Audible alarm	
4090	U8	Acknowledgement duration	
Alarm 2			
4100	U8	Alarm mode	0: None, 1: Min, 2: Max, 3: Min/Max
4110	F32	Hysteresis	
4120	F32	Threshold Up	
4130	F32	Threshold Down	
4140	U32	Delay Time	
4150	U32	Delay End	
4160	BOOLEAN	Enabled/Disabled	
4180	BOOLEAN	Audible alarm	
4190	U8	Acknowledgement duration	
Alarm 3			
4200	U8	Alarm mode	0: None, 1: Min, 2: Max, 3: Min/Max
4210	F32	Hysteresis	
4220	F32	Threshold Up	
4230	F32	Threshold Down	
4240	U32	Delay Time	
4250	U32	Delay End	
4260	BOOLEAN	Enabled/Disabled	
4280	BOOLEAN	Audible alarm	
4290	U8	Acknowledgement duration	

12.4.5 Probes and module parameters

Modbus	Register type	Description	Possibilities
6000	F32	Lower limit of probe range, for each available measure	For maximum 10 measures (@6000: lower range of measure 1, @6002: lower range of measure 2, etc...)
6020	F32	Upper limit of probe range, for each available measure	For maximum 10 measures (@6000: upper range of measure 1, @6002: upper range of measure 2, etc...)
6040	U8	Atmospheric pressure compensation unit	
6050	F32	Atmospheric pressure compensation value. In case of pressure, this value is used for velocity calculation	In Pa.
6060	U8	Type of pressure equipment plugged in order to determine the air velocity	0: Pitot tube S, 1: Pitot tube L, 2: de-bimo blades, 3: other (set pressure Equipment Coeff instead), 4: None

6070	F32	Custom coefficient for pressure device plugged in order to determine the air velocity	From 0.0001 to 9.9999.
6080	U8	Room volume unit	
6090	F32	Room volume value in cubic meter used for computing air renewing rate (ACR)	In cubic meter.
6100	U8	Measurement integration	From 0 to 9.
6110	U8	Temperature compensation mode	0: Use internal sensor, 1: Manual – refer to user value, 2: Use probe id 0 (or user if not present), 3: Use probe id 1 (or user if not present), 4: Use probe id 2 (or user if not present)
6120	U8	Manual temperature compensation unit	
6130	F32	Manual temperature compensation value in Celsius degrees	From -50 to 50, in Celsius degrees.
6140	F32	Correction factor used for air velocity and airflow probes	From 0.2 to 2 - Used for air velocity and airflow probes (default = 1).
6150	U8	Type of section used for air velocity and airflow probes	0: rectangular, 1: circular, 2: other (set airflow coefficient instead), 3: None (not configured)
6160	U8	Unit for section diameter, section length and section width	
6170	F32	Section diameter value in meters (used when section type is circular)	From 0.001 to 3.
6180	F32	Section length value in meters (used when section type is rectangular)	From 0.001 to 3.
6190	F32	Section width value in meters (used when section type is rectangular)	From 0.001 to 3.
6200	F32	Airflow coefficient (allows to calculate an airflow from the pressure)	From 0.1 to 9999.9.

12.4.6 Normative values

Modbus	Register type	Description	Possibilities
6900	U8	Normative Value	

12.4.7 Alarms

Modbus	Register type	Description	Possibilities
7000	BOOLEAN	Alarm 1 raised	
7010	F32	Channel 1 measured value	In unit selected for the channel (cf register 2000).
7020	U8	Channel 1 measure status	0: OK, 1: Out of range, 2: Error, 3: Heating
7030	I8	Channel 1 trend	0: down, 1: equal, 2: up, 3: unavailable

7040	U8	Channel 1 error reason	0: none, 1: internal, 2: not configured, 3: measure, 4: unplugged probe, 5: invalid probe, 6: probe to update
7100	BOOLEAN	Alarm 2 raised	
7110	F32	Channel 2 measured value	In unit selected for the channel (cf register 2100).
7120	U8	Channel 2 measure status	0: OK, 1: Out of range, 2: Error, 3: Heating
7130	I8	Channel 2 trend	0: down, 1: equal, 2: up, 3: unavailable
7140	U8	Channel 2 error reason	0: none, 1: internal, 2: not configured, 3: measure, 4: unplugged probe, 5: invalid probe, 6: probe to update
7200	BOOLEAN	Alarm 3 raised	
7210	F32	Channel 3 measured value	In unit selected for the channel (cf register 2200).
7220	U8	Channel 3 measure status	0: OK, 1: Out of range, 2: Error, 3: Heating
7230	I8	Channel 3 trend	0: down, 1: equal, 2: up, 3: unavailable
7240	U8	Channel 3 error reason	0: none, 1: internal, 2: not configured, 3: measure, 4: unplugged probe, 5: invalid probe, 6: probe to update

13. Maintenance and precautions for use

13.1 Maintenance

Please avoid any aggressive solvents. Please protect the transmitter and its probes from any cleaning product containing formalin, that may be used for cleaning rooms or ducts.

13.2 Precautions for use

Please always use the device in accordance with its intended use and within parameters described in the user manual in order not to compromise the protection ensured by the device.

Sauermann Industrie

ZA Bernard Moulinet
24700 Montpon
France
T. +33 (0)5 53 80 85 00
services@sauermanngroup.com

Sauermann NA

140 Fell Court, Ste. 302
Hauppauge, New York 11788
T. (+1) 631-234-7600
F. (+1) 631-234-7605
services@sauermanngroup.com

Sauermann GmbH

Leibnizstraße 6
D – 74211 Leingarten
T. +49 (0)7131/399990
F. +49 (0)7131/399992
services@sauermanngroup.com

Sauermann UK

Units 7-9, Trident Business Park
Amy Johnson Way
Blackpool - FY4 2RP
T. +44 (0) 870 950 6378
F. +44 (0) 870 950 6379
services@sauermanngroup.com

Sauermann Italia srl SU

Via Golini 61/10
40024 Castel S.Pietro Terme (BO)
T. (+39)-051-6951033
F. (+39)-051-942254
services@sauermanngroup.com

Sauermann Ibérica

C/Albert Einstein 33.
Planta 3. P. I. Santa Margarida II-
08223 Terrassa (Spain)
T. +34 931 016 975
services@sauermanngroup.com

Sauermann Australia

1/36 Campbell Avenue, Cromer ,2099,
NSW, Sydney
T. (+612) 8880 4631
services@sauermanngroup.com



BE CAREFUL! Material damages can happen, so please apply the precautionary measures indicated.